

MBX 22/9 T4 0,55kW

Series general data MBX



MANUFACTURING FEATURES

- Rolling steel sheet housing.
 - Completely joined or welded housing.
 - Single inlet forward curved impeller made of aluminium sheet.
 - Epoxy powder finishing coat.
 - Inlet sparkproof ring made of copper or aluminium.
 - Standard asynchronous squirrel-cage motor with IP-55 protection and Class F insulation. ATEX certified EEx-d.
- Manufactured with standard voltages: 230V 50Hz in single phase motors and 230/400V 50Hz in three phase motors up to 4kW, and 400/690V 50Hz for higher powers.

APPLICATIONS

- Designed for inline installation, they are suitable for:
- General ventilation in closed environments classified as ATEX zone 2 or 22.
 - Maximum air working temperature from -20°C to 80°C.

UNDER REQUEST

- 60Hz fans and special voltages.
- Special ATEX executions.

In compliance with the 94/9/CE Directive. ATEX II2G built. Certified II3G with certified ATEX EEx-d II2G motor for areas 2 (gas) or 22 (dust).

Series accessories MBX



Characteristic curve

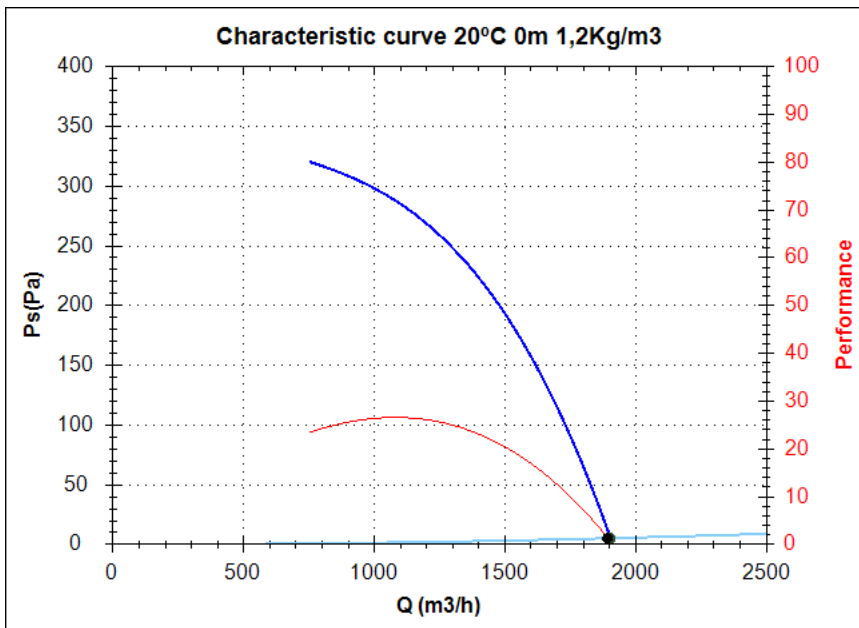

Design point

Q (m ³ /h)	1891,32
Ps(Pa)	5,2

Service point

Impeller rpm	1400
Max. temp.(°C)	200
Q (m ³ /h)	1904,00
Ps(Pa)	5,27
Pd(Pa)	259,11
Pt(Pa)	264,38
Air speed(m/s)	20,78
Perf.(%)	0,67
SWL dB(A)	85 (INLET)
SPL dB(A)	70 (INLET)
Distance(m)	1,5

Technical data

Impeller rpm	1400
Motor rpm	1400
Approx. weight(kg)	22
Maximum flow rate(m ³ /h)	1930

Power(kW)	0,55
Imax 230V(A)	2,69
Imax 400V(A)	1,56
Imax 690V(A)	-

MBX 22/9 T4 0,55kW

Acoustics to the service point (INLET)

Power dB(A)

63 Hz	54
125 Hz	66
250 Hz	73
500 Hz	74
1000 Hz	79
2000 Hz	80
4000 Hz	76
8000 Hz	72
Total dB(A)	85

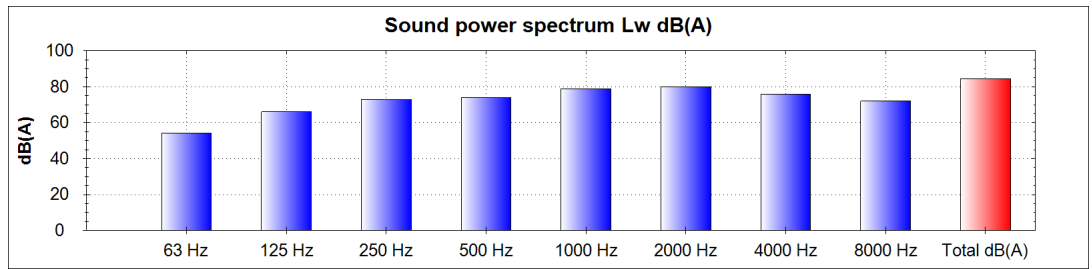

Pressure dB(A) [1,5 m]

63 Hz	39
125 Hz	51
250 Hz	58
500 Hz	59
1000 Hz	64
2000 Hz	65
4000 Hz	61
8000 Hz	57
Total dB(A)	70

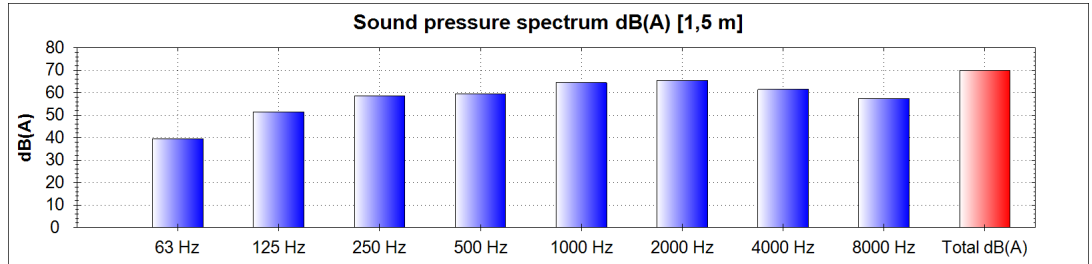

dimensions diagram

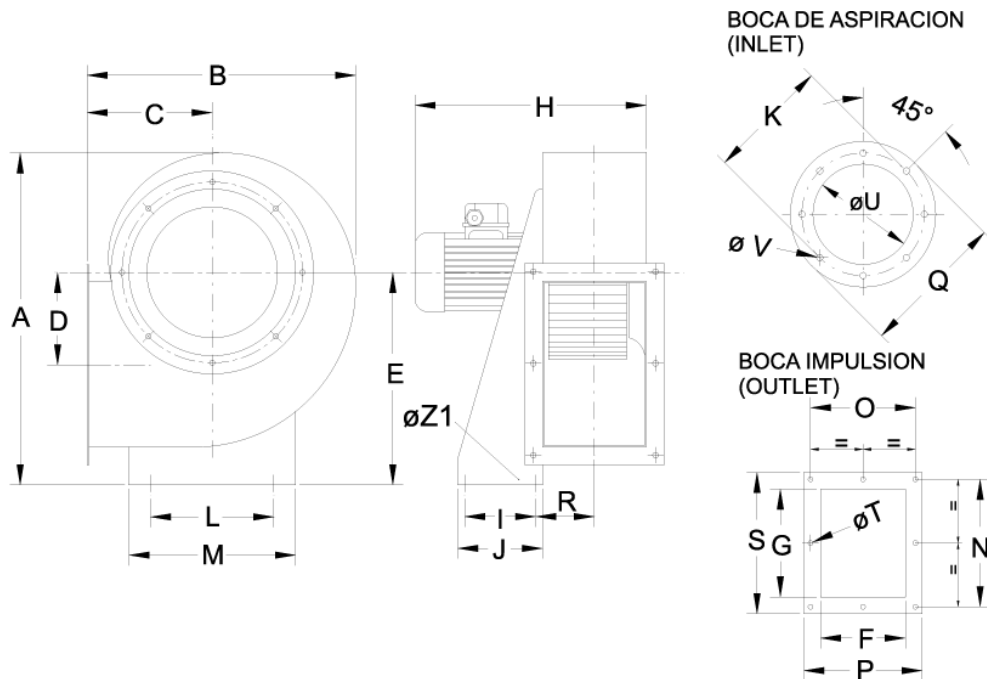

Dimensions (mm)

A=452	B=386	C=181	D=134	E=280	F=140	G=216	H=381	I=50	J=110	K=256	L=220
M=290	N=256	O=280	P=204	Q=280	R=100	S=282	TØ=9	UØ=180	VØ=9	Z1Ø=11	

Wiring diagram

