

MBX 40/16 T4 7,5kW

Series general data MBX



MANUFACTURING FEATURES

- Rolling steel sheet housing.
 - Completely joined or welded housing.
 - Single inlet forward curved impeller made of aluminium sheet.
 - Epoxy powder finishing coat.
 - Inlet sparkproof ring made of copper or aluminium.
 - Standard asynchronous squirrel-cage motor with IP-55 protection and Class F insulation. ATEX certified EEx-d.
- Manufactured with standard voltages: 230V 50Hz in single phase motors and 230/400V 50Hz in three phase motors up to 4kW, and 400/690V 50Hz for higher powers.

APPLICATIONS

- Designed for inline installation, they are suitable for:
- General ventilation in closed environments classified as ATEX zone 2 or 22.
 - Maximum air working temperature from -20°C to 80°C.

UNDER REQUEST

- 60Hz fans and special voltages.
- Special ATEX executions.

In compliance with the 94/9/CE Directive. ATEX II2G built. Certified II3G with certified ATEX EEx-d II2G motor for areas 2 (gas) or 22 (dust).

Series accessories MBX



Characteristic curve

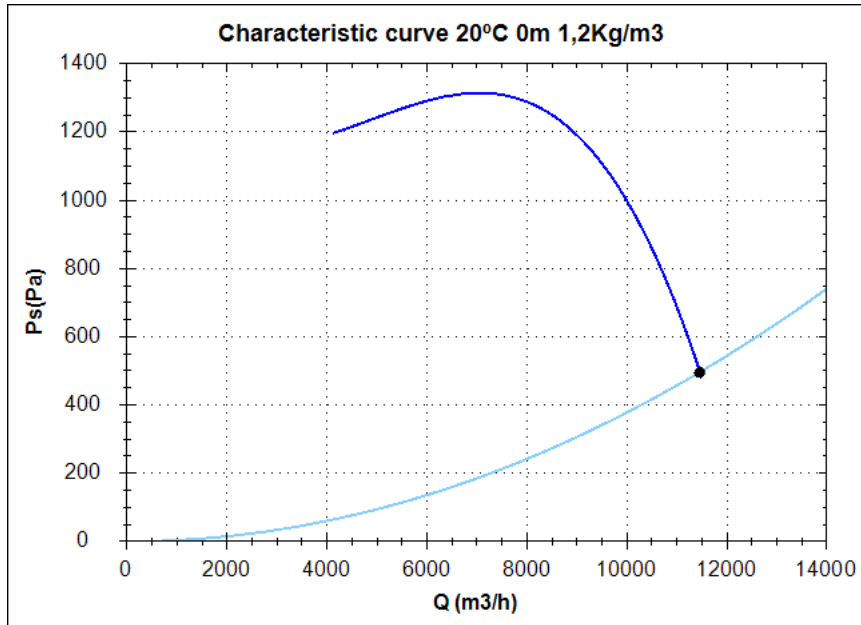

Design point

Q (m ³ /h)	11444,88
Ps(Pa)	495,16

Service point

Impeller rpm	1440
Max. temp.(°C)	250
Q (m ³ /h)	11462,03
Ps(Pa)	496,65
Pd(Pa)	883,55
Pt(Pa)	1380,19
Air speed(m/s)	38,38
SWL dB(A)	103 (INLET)
SPL dB(A)	89 (INLET)
Distance(m)	1,5

Technical data

Impeller rpm	1440
Motor rpm	1440
Approx. weight(kg)	110
Maximum flow rate(m ³ /h)	11500

Power(kW)	7,5
Imax 230V(A)	-
Imax 400V(A)	15
Imax 690V(A)	-

MBX 40/16 T4 7,5kW

Acoustics to the service point (INLET)

Power dB(A)

63 Hz	73
125 Hz	86
250 Hz	92
500 Hz	93
1000 Hz	98
2000 Hz	99
4000 Hz	95
8000 Hz	92
Total dB(A)	103

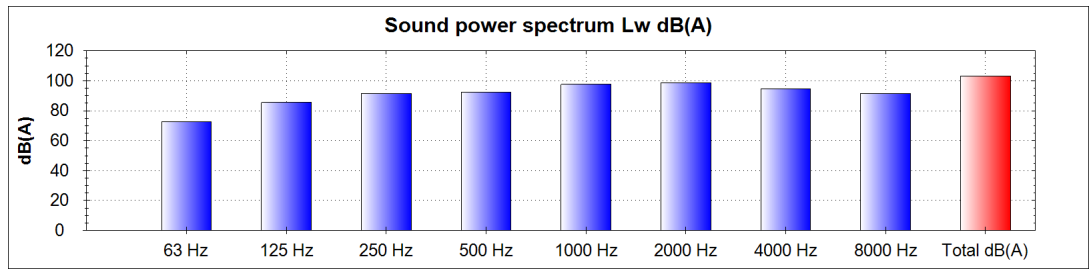

Pressure dB(A) [1,5 m]

63 Hz	58
125 Hz	71
250 Hz	77
500 Hz	78
1000 Hz	83
2000 Hz	84
4000 Hz	80
8000 Hz	77
Total dB(A)	89

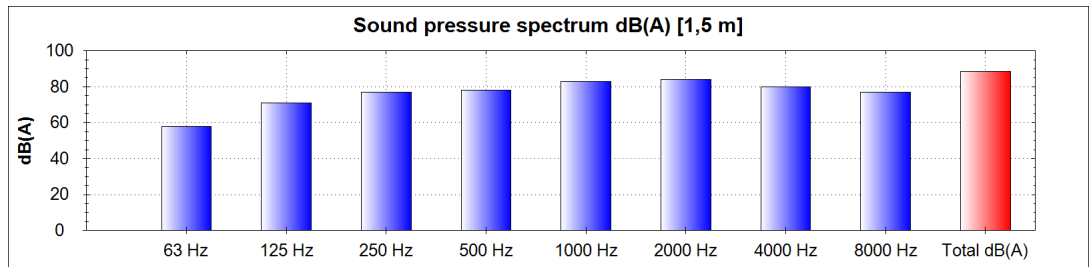

dimensions diagram

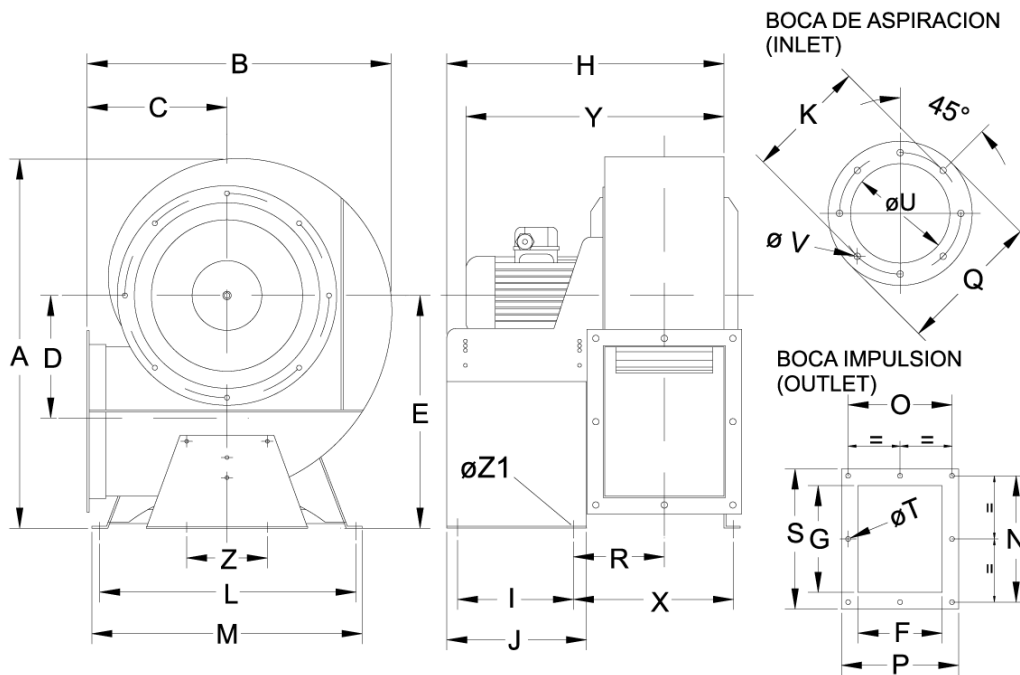

Dimensions (mm)

A=795	B=649	C=300	D=273	E=499	F=250	G=320	H=595	I=240	J=290	K=438	L=560
M=590	N=370	O=300	P=336	Q=464	R=192	S=406	TØ=11	UØ=325	VØ=11	X=355	Y=595
Z=200	Z1=13										

Wiring diagram

