

MBPX 35 T6 0,18kW (503003568)

DATE GENERALE



VENTILATOR ATEX DIN POLIPROPILENA CU ROTOR CU PALE ORIENTATE SPRE INAINTE
CARACTERISTICI CONSTRUCTIVE

- Carcasa din polipropilena (PE-el) antistatica.
- Rotor din polipropilena cu pale orientate spre inainte.
- Suportul motorului este protejat impotriva coroziunii cu vopsea pe baza de rasini epoxidice
- Motor asincron in scurtcircuit, grad protectie IP-55 si clasa de izolatie F.Tensiuni de alimentare 230/400V 50Hz.Echipat cu motor II2G Eex-d.

APLICATII

Conceput pentru montaj pe tubulatura, recomandat pentru:

- Functionare in mediu coroziv.
- Industria chimica si petrochimica.
- Laboratoare si nise.
- Ventilatie in medii ce pot prezenta risc de explozie.
- Temperatura maxima de lucru: 50°C.

OPTIUNI

- Motoare la 60Hz si tensiuni speciale.
- Suport pentru motor din inox.

In conformitate cu Directiva 94/9/CE. Fabricat ATEX II2G.Motor certificat II3G si certificat ATEX EEx-d II2G pentru zonele 2 (gaz) si 22 (praf).

CURBA CARACTERISTICA

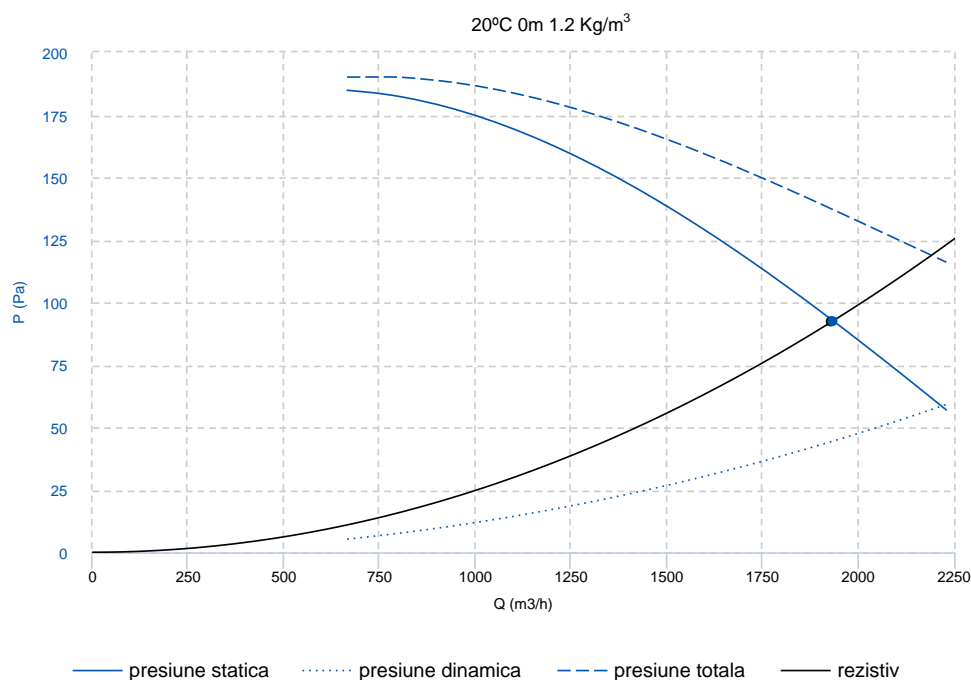

Punct proiectare

Q (m ³ /h)	1931.57
P (Pa)	92.34

Punct de lucru

Temp. max. (°C)	50
Q (m ³ /h)	1935.15
Ps 9Pa	92.47
Pd (Pa)	44.53
Pt (Pa)	137.01
Val. aer (m/s)	8.62

DATE TEHNICE

fan

RPM	880	greutate aprox.	23 kg	debit maxim	2230 m ³ /h
-----	-----	-----------------	-------	-------------	------------------------

motor

putere	0.18 kW
--------	---------



DATE ACUSTICE

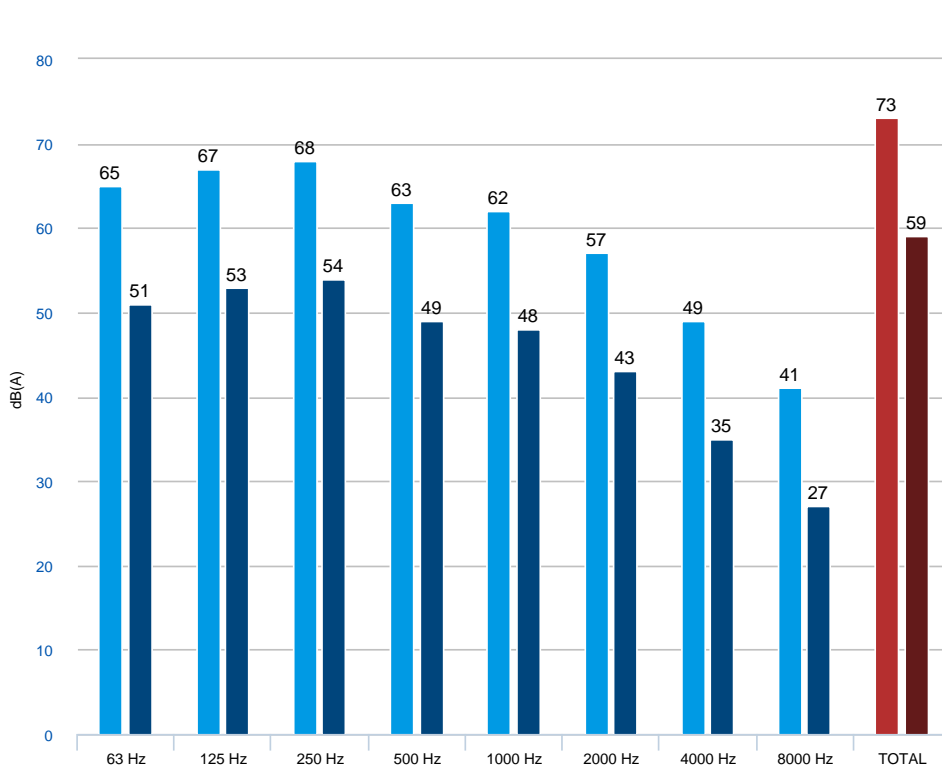

Putere de zgomot Lw dB(A)

63 Hz	65
125 Hz	67
250 Hz	68
500 Hz	63
1000 Hz	62
2000 Hz	57
4000 Hz	49
8000 Hz	41
TOTAL	73

Presiune sonora Lw dB(A) 1.5 m (INLET)

63 Hz	51
125 Hz	53
250 Hz	54
500 Hz	49
1000 Hz	48
2000 Hz	43
4000 Hz	35
8000 Hz	27
TOTAL	59

DIMENSIUNI DIAGRAMA

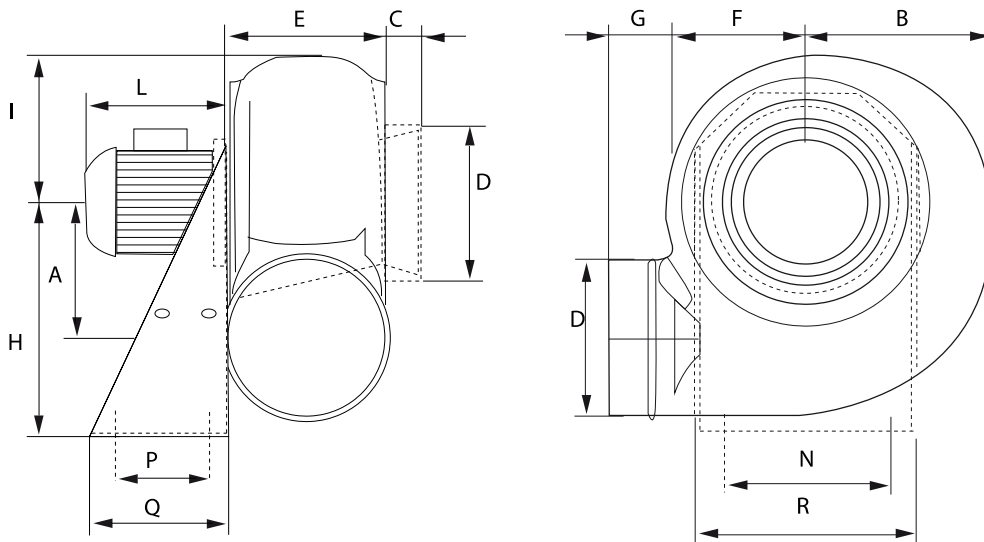

Dimensiuni (mm)

A	260	B	312	C	40	D \varnothing	280	E	220
F	230	G	80	H	445	I	270	L	210
N	350	P	150	Q	230	R	385	S	11

DIAGRAMA CONEXIUNILOR ELECTRICE

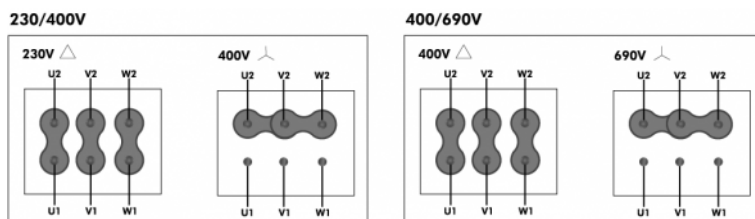

ACCESORII



**COMUTATOR DE SIGURANTA
INT 6,5 1V**
REF: FX452508



**KIT PRESURIZARE
Easy KPE SP 0,37kW**
REF: 508800102



**KIT PRESURIZARE
Easy KPE TP 0,75kW**
REF: 508800344



**CONVERTIZOR DE FRECVENTA
SFC M 0,37kW**
REF: 960002520



**CONVERTIZOR DE FRECVENTA
SFC T 0,55kW**
REF: 960002526

PIESE DE SCHIMB

	cod	categorie	model	RPM	Grade de inclinare
1	T03003568	1 x TURBINA	MBPX 35 T6 0,18 kW LG		