

INSTALLATION MANUAL

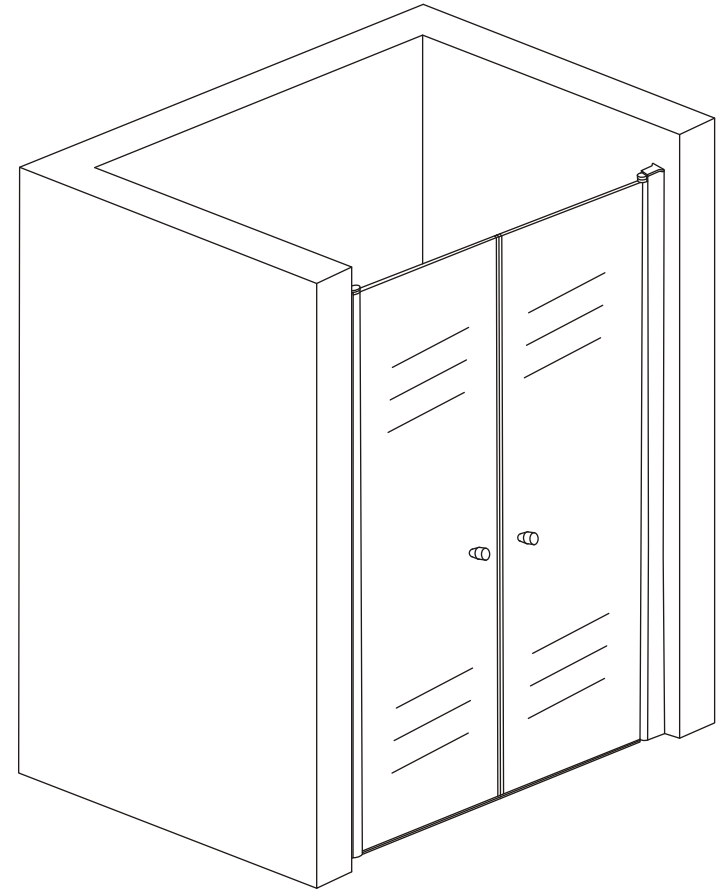

BL-017S

RoHS  ISO9001:2000

TOOL PICTURE

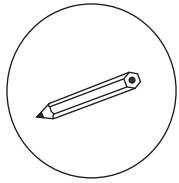

Pencil

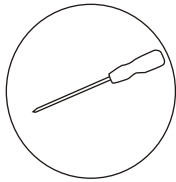

Cross screw driver

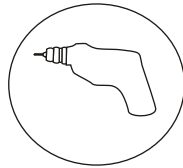

Drill machine

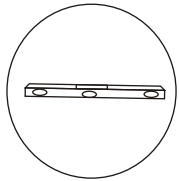

Level ruler

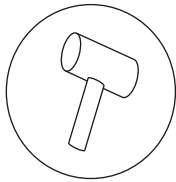

Rubber hammer

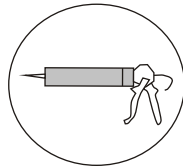

Silicon gel

Accessory list

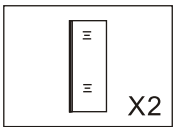

Glass X2

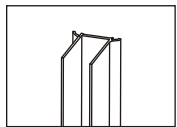

Wall profile

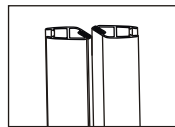

CT-6BMX90

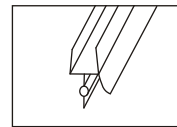

water-proof gasket

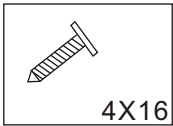

Screw 4X16

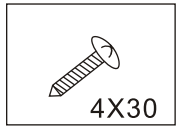

Screw 4X30

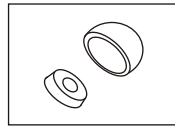

PJ-4553

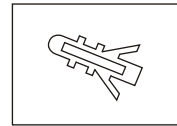

Expand tube

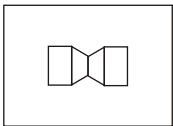

LS-1201

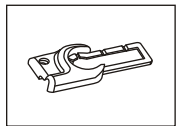

PJ-4644

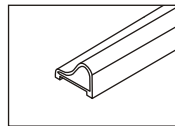

Aluminum bottom bar

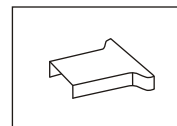

PJ-4643

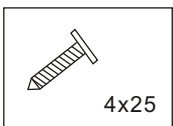

Screw 4x25

1. Use 3.2mm drill bit to make two holes on the aluminium and use screws to fix.
2. Install handle on the door.
3. Install the cap on the top .

Attention: Do not use any corrosion liquid to clean the aluminum and other metal parts when daily maintenance.

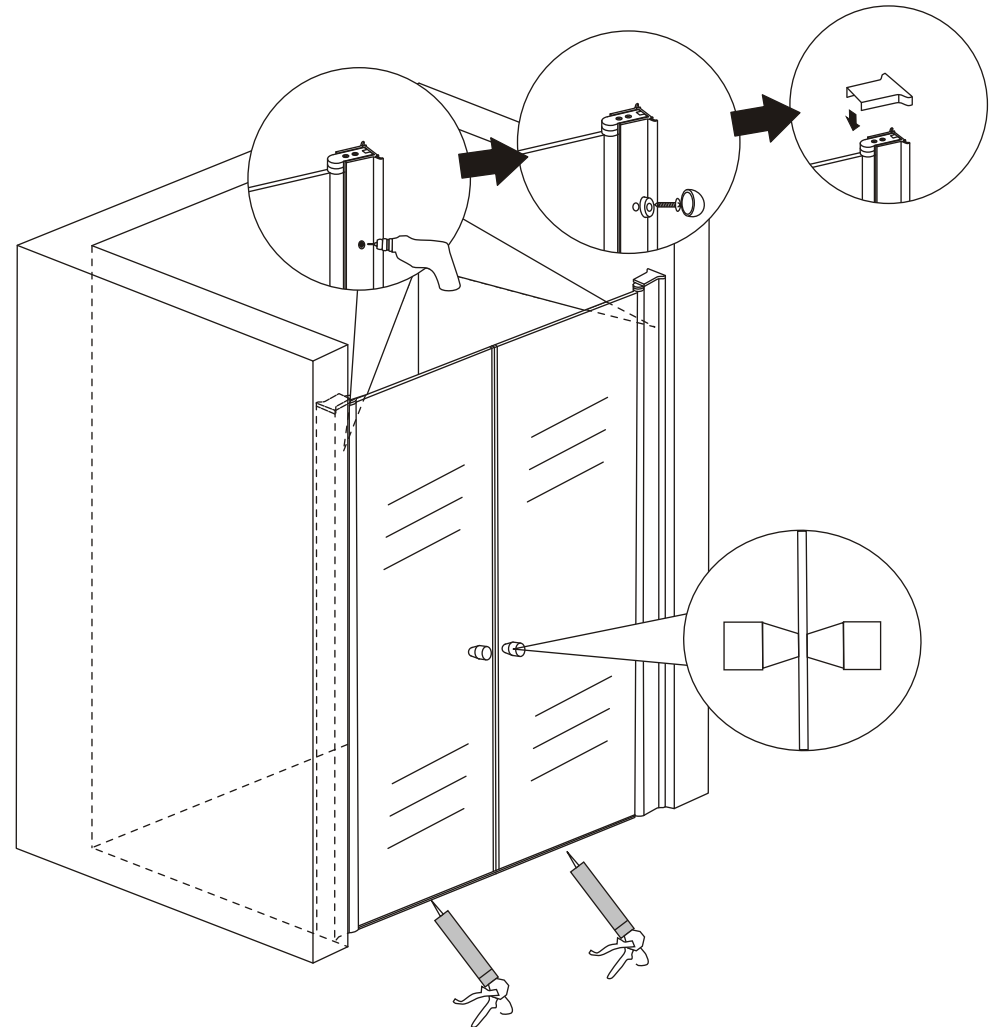
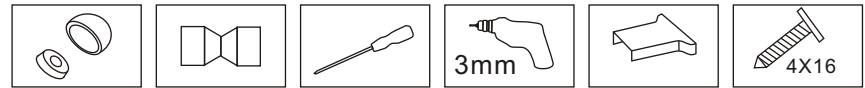

1. Insert one glass door to the wall aluminum profile.
2. Install the decorating parts on the water-proof aluminum profile.
Insert the glass door into the decorating parts. Make sure the install position of the aluminum profile decorating parts, then paint line, punching, insert the expansion screws, tighten the screws and fixed the decorating parts.

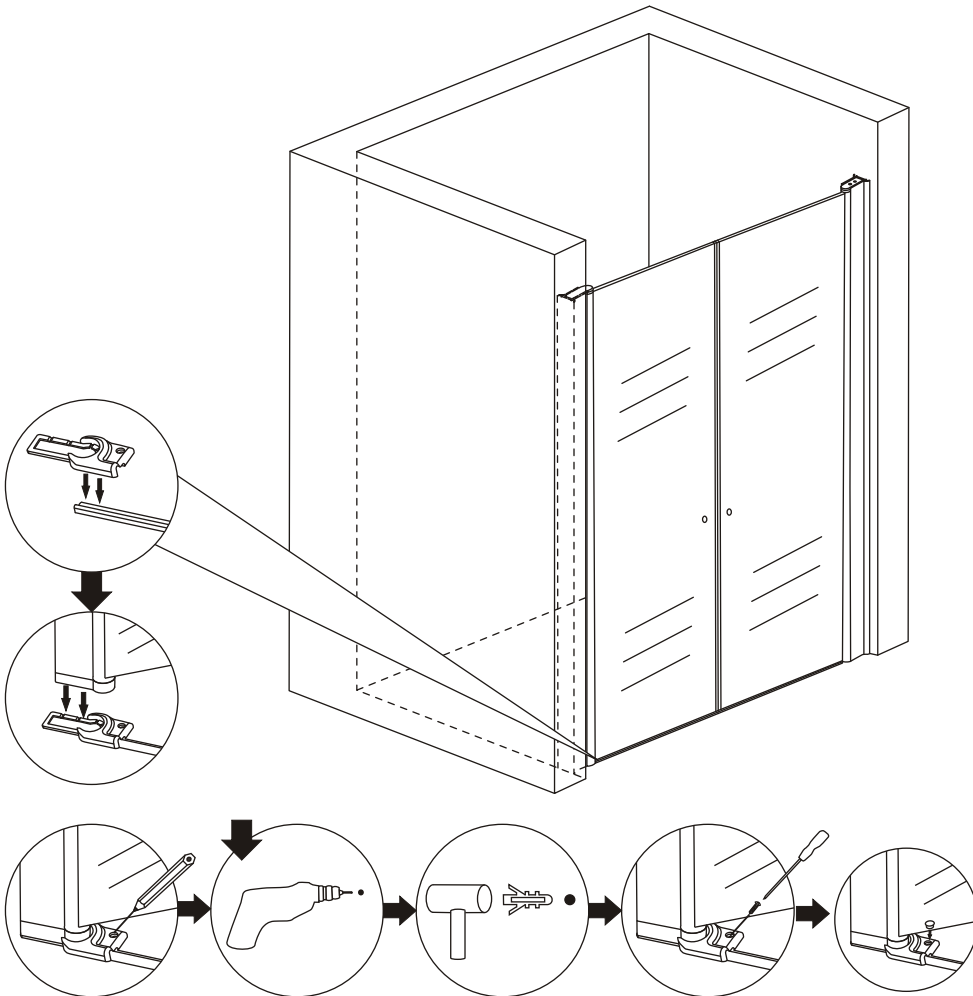
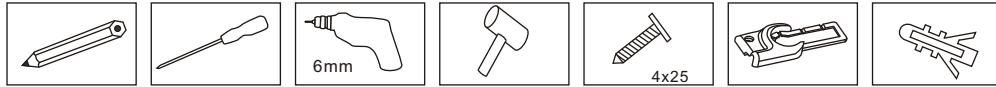

5

1. Put aluminium profile on the wall and use level ruler to make it straight.
2. Use pencil draw holes on the wall.
3. Use 6mm drill bit to make holes on the wall.
4. Insert screw space pipe in the wall and screw it.

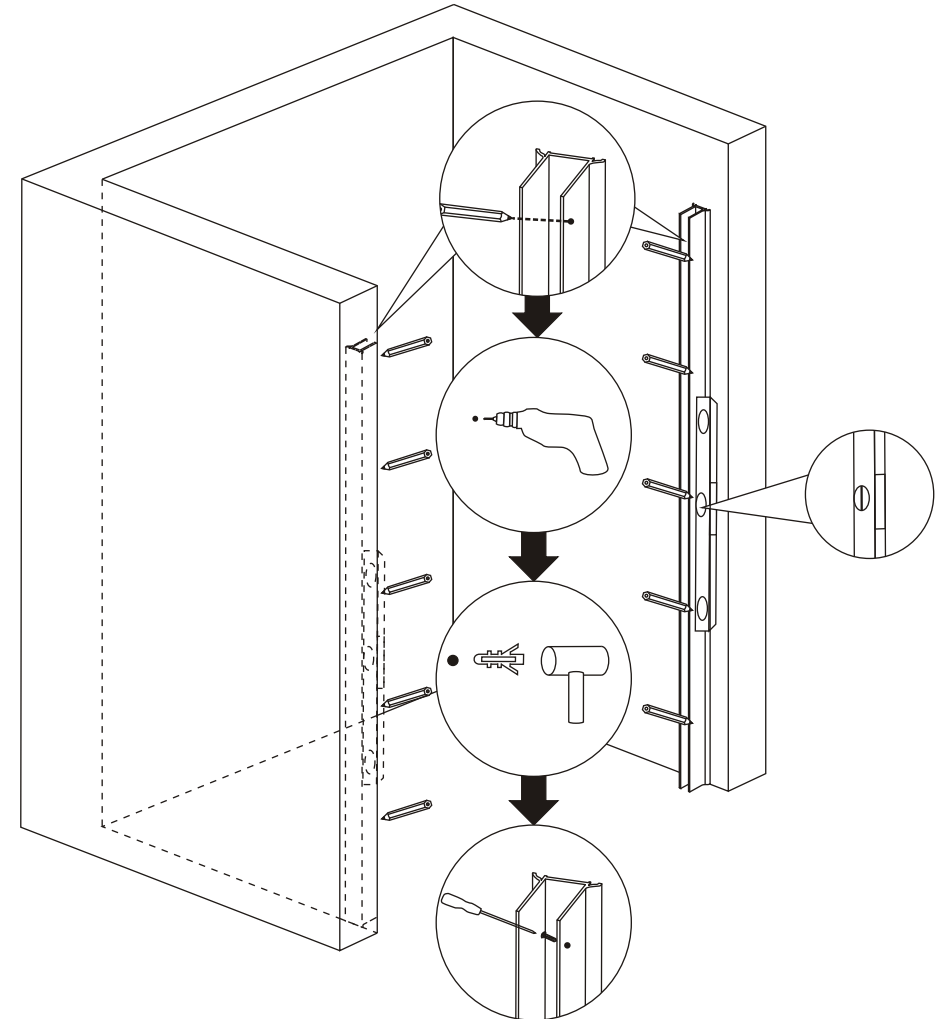
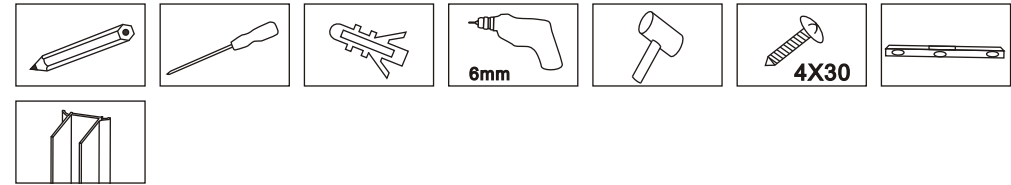

2

1. Install the gasket at the bottom of glass.
2. Cut the length and angle of the water-proof gasket according to the actual situation, then install it.

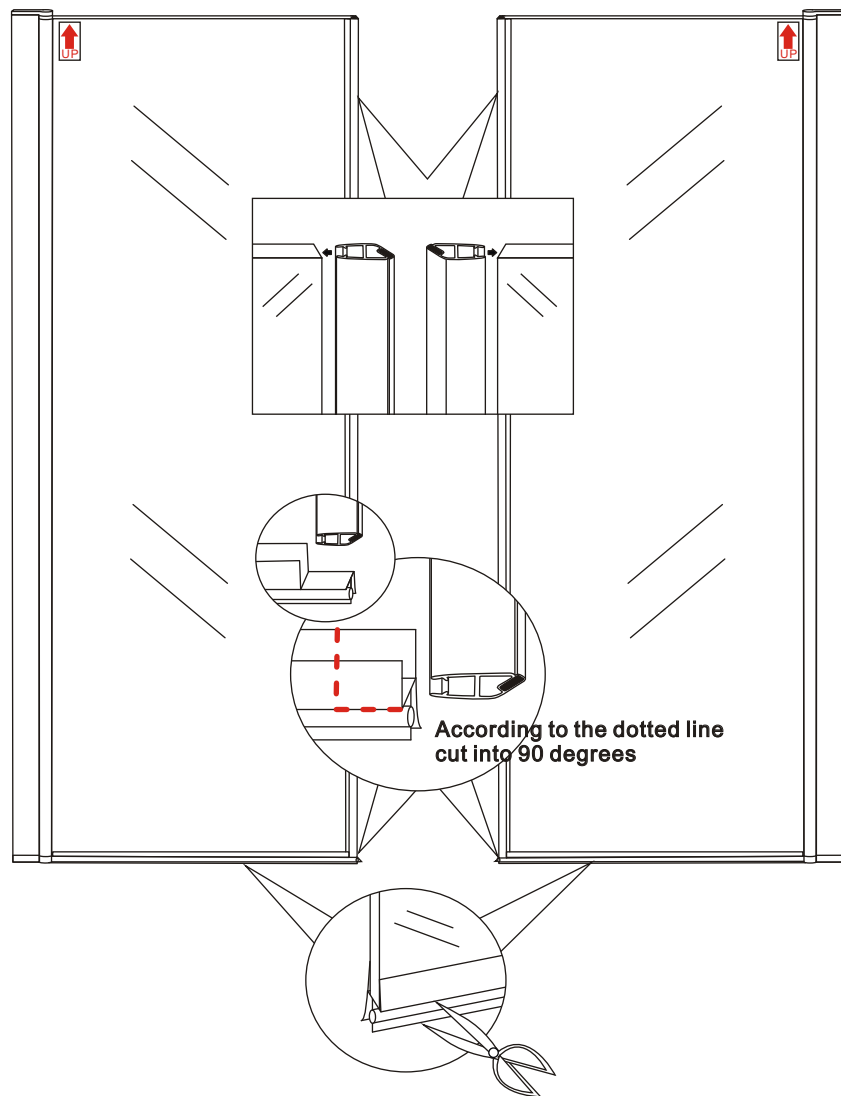
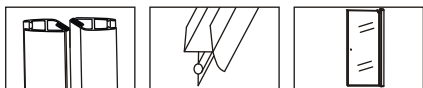

3

1. Insert one glass door to the wall aluminum profile.
2. Install the decorating parts on the water-proof aluminum profile. Insert the glass door into the decorating parts. Make sure the install position of the aluminum profile decorating parts, then paint line, punching, insert the expansion screws, tighten the screws and fixed the decorating parts.

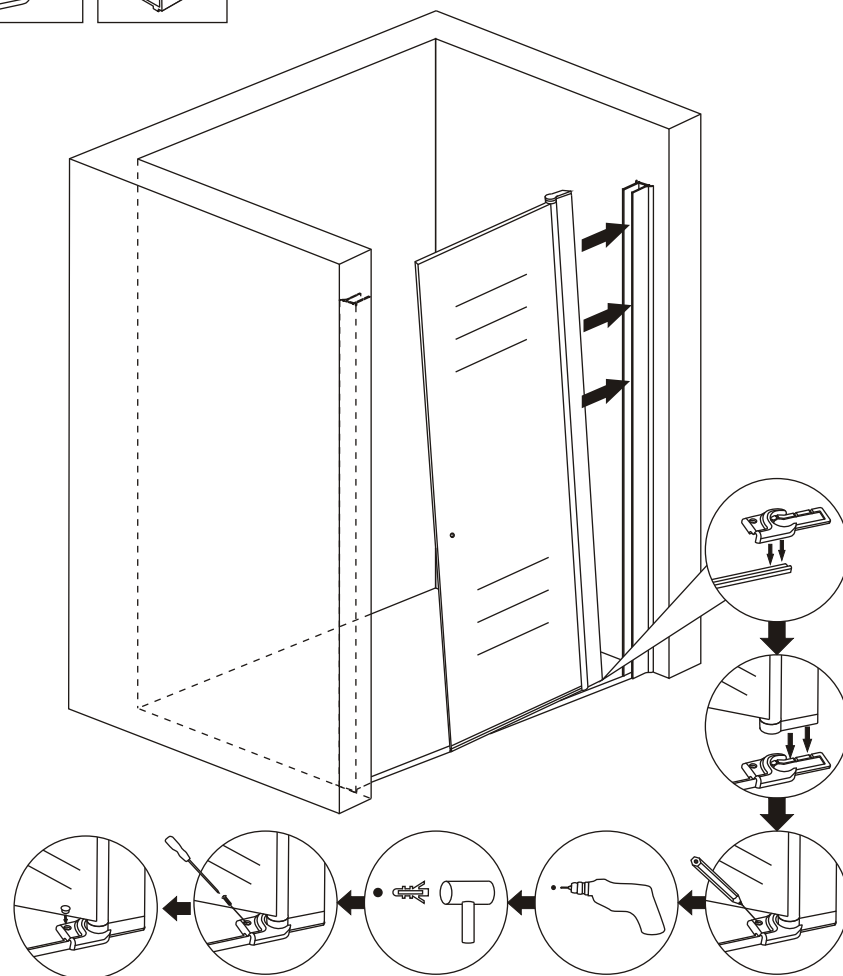
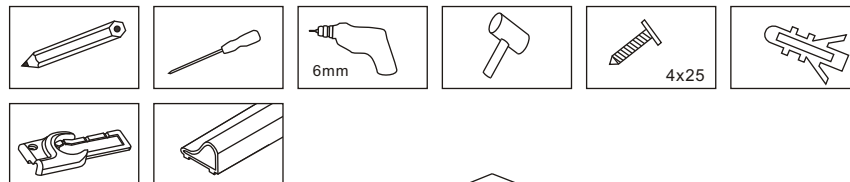

4