

INSTALLATION MANUAL

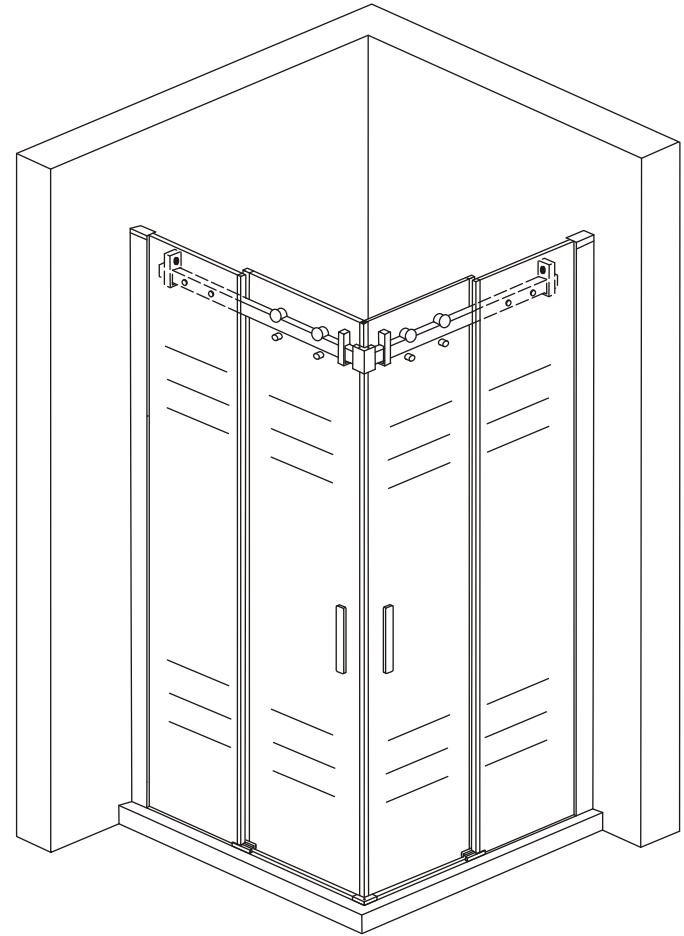

BL-046

RoHS **CE** ISO9001:2000

TOOL PICTURE

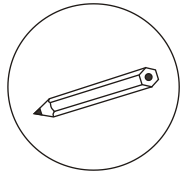

Pencil

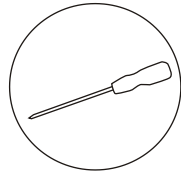

Cross screw driver



Drill machine (6mm)

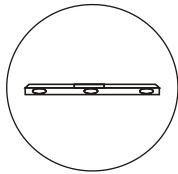

Level ruler

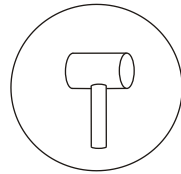

Rubber hammer

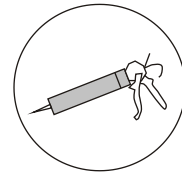

Silicon gel

Accessory list

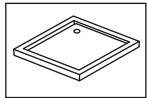

Tray

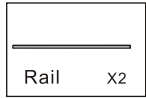

Rail x2

Rail bar



PJ-4579

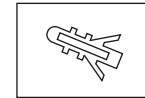

Expand tube

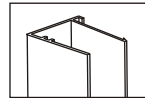

Wall profile

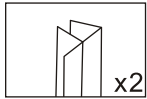

CT-8DST90

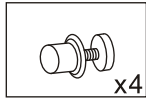

PJ-4419

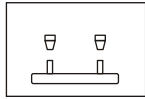

LS-1009

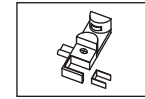

PJ-4131

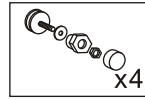

LZ-5012

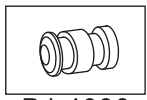

PJ-4038

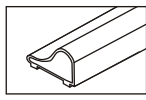

PJ-4026

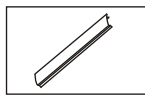

Side cover

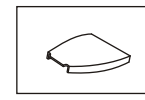

PJ-4509

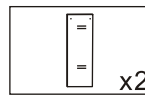

Glass



CT-8BMX90

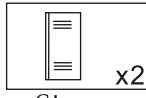

Glass



PJ-4032



Screw

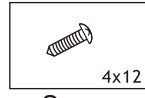

Screw

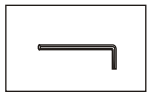

Aluminum bottom bar

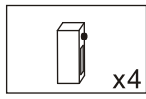

PJ-4012

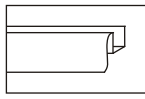

8S-180

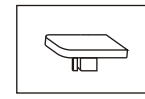

PJ-4509

1. Install the magnetic stripe
2. Install the aluminum decoration.
3. Install the handle
4. Make the silica gel.

Attention: Do not use any corrosion liquid to clean the aluminum and other metal parts when daily maintenance.

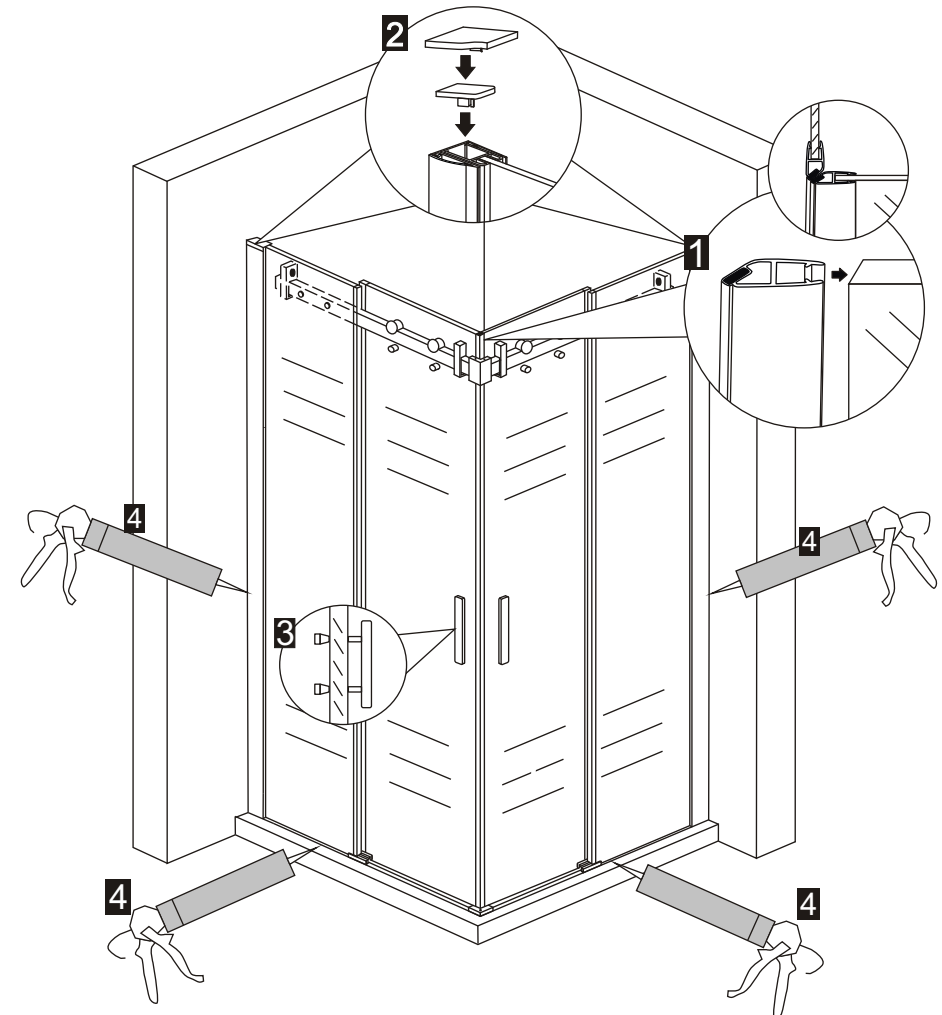
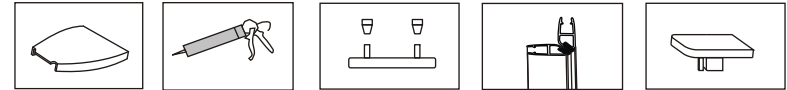

1. Put the door glass onto the rail and keep the bottom part of the door glass into the bottom rectangle metal part .
2. Install the small glass holder and fasten it onto the glass. Pls note you must adjust well the roller to make sure the small glass holder match close to rail at about 0.5-1mm to prevent the glass fall down or coming out .
3. Install the water-proof strip.
4. Install the aluminum cap.

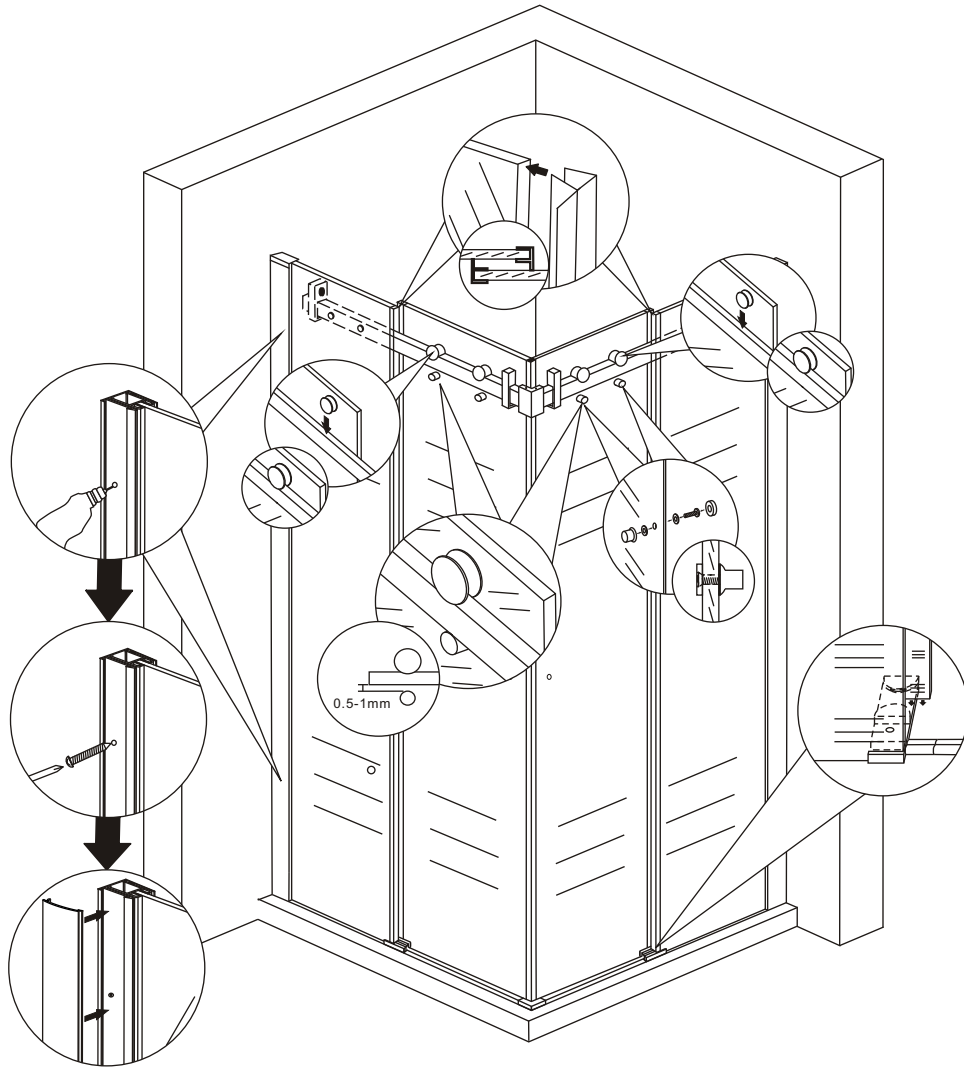
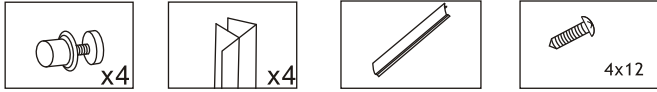

1. Put the shower tray on the installation place and use level rule make it flat.

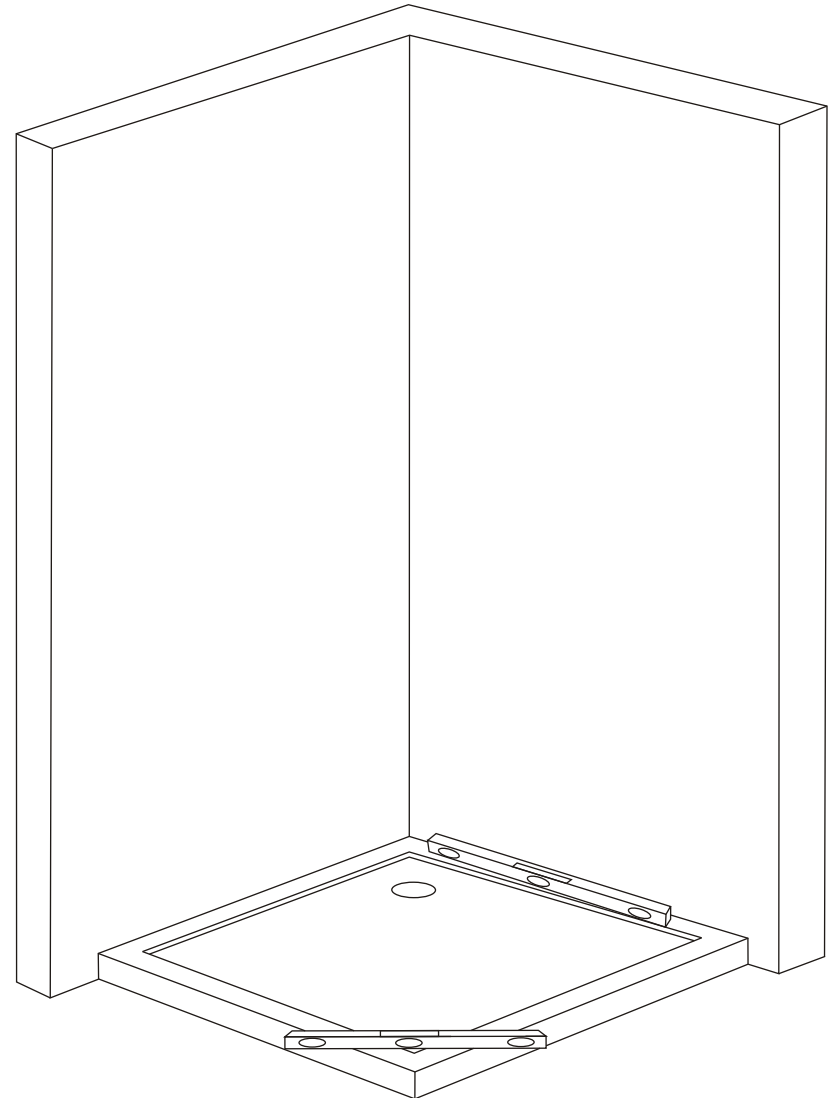
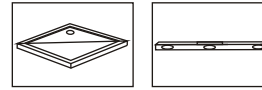

1. Use pencil and ruler draw the vertical installation line

shower enclosure size	The installation size L1	The installation size L2
(680-700)X(1180-1200)	655-675	1155-1175
(780-800)X(1180-1200)	755-775	1155-1175
(680-700)X(880-900)	655-675	855-875

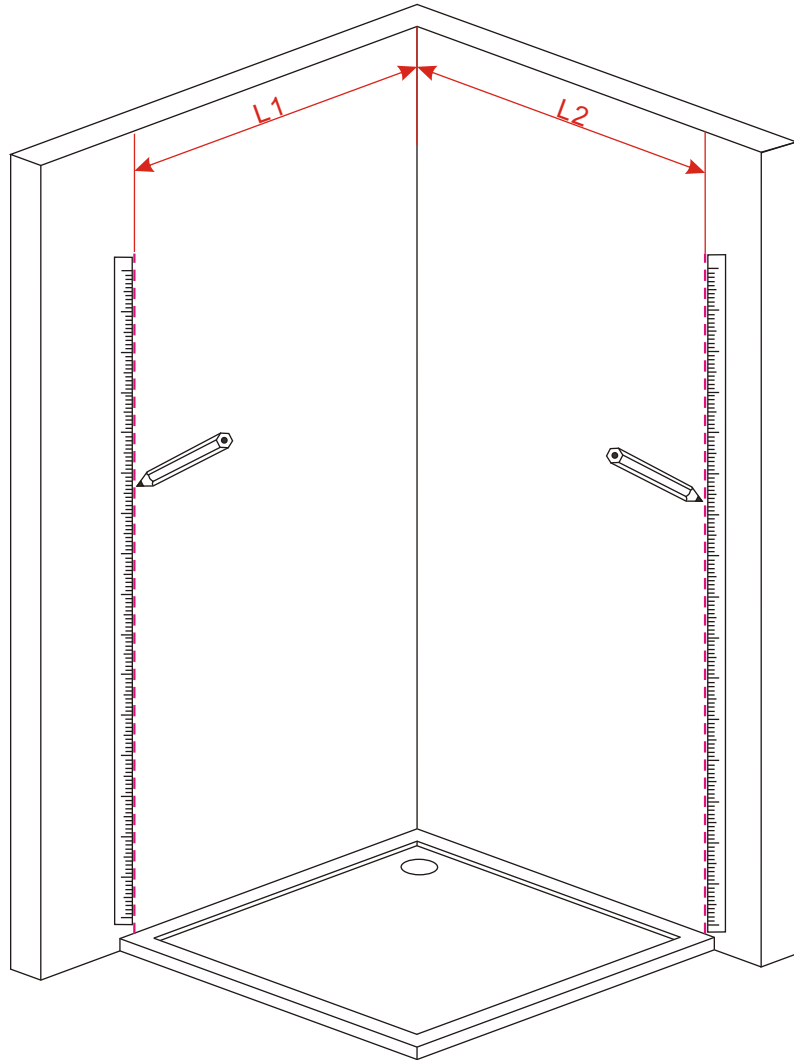

3

1. Install the rollers on the door glass and fix them tightly.

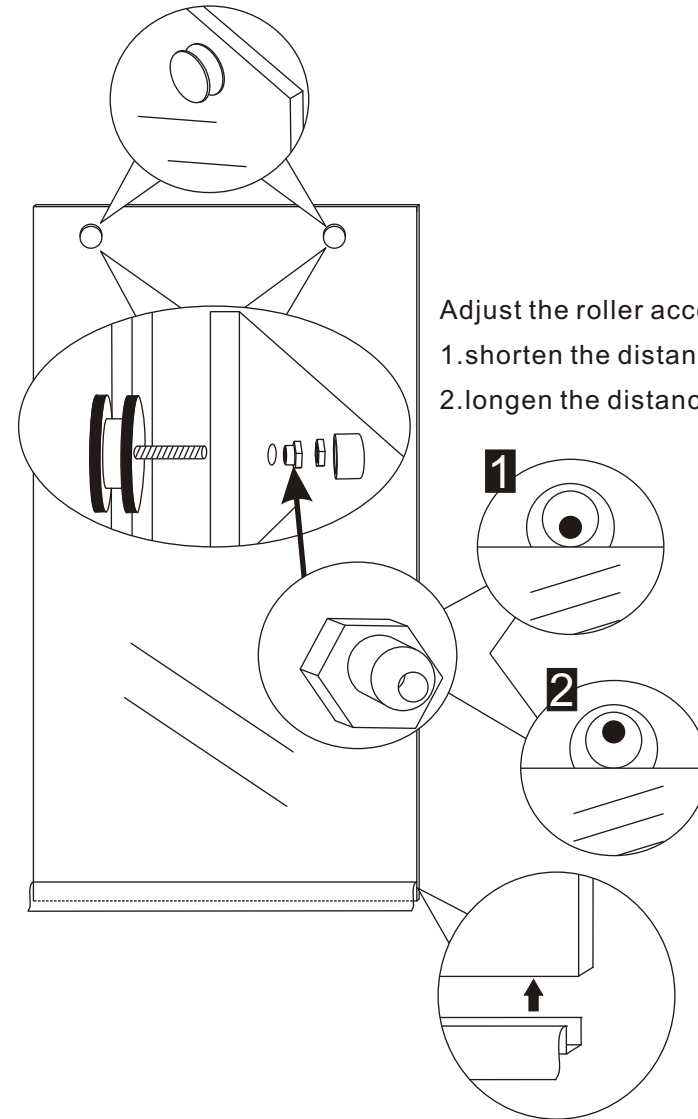
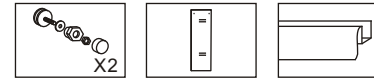

Adjust the roller accordingly:

1. shorten the distance of glass and the rail.
2. lengthen the distance of the glass and rail.

8

1. Insert the rectangle metal part into the fixed glass, make sure the position and tighten the screws, Install the decorative pieces (as the picture show).
2. Install the water-proof aluminum profile.
3. Insert the 90° water-proof aluminum profile into the fixed glass and tighten the screws.

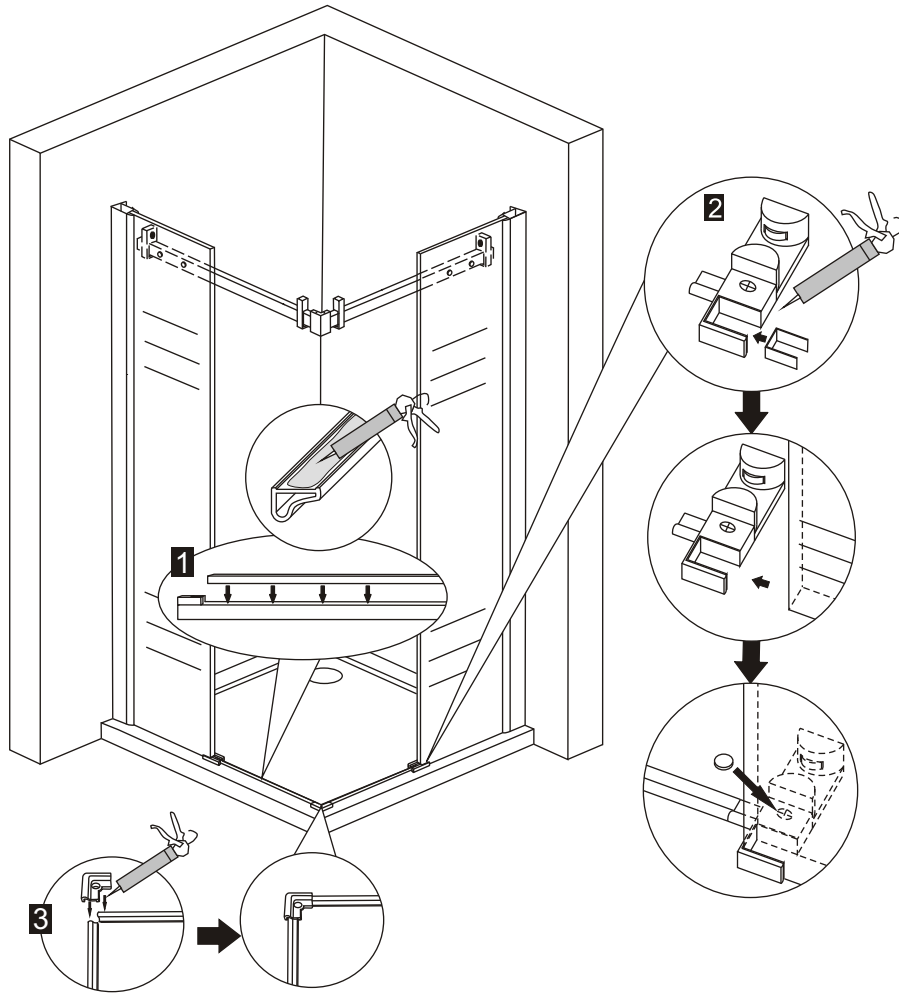
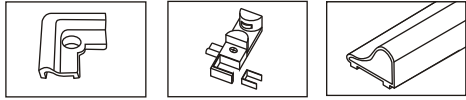

1. put the aluminum profile on the wall and use level rule make it stright.
2. use pencil draw a hole.
3. use dirll machine make drill.
4. Tighten the screw.

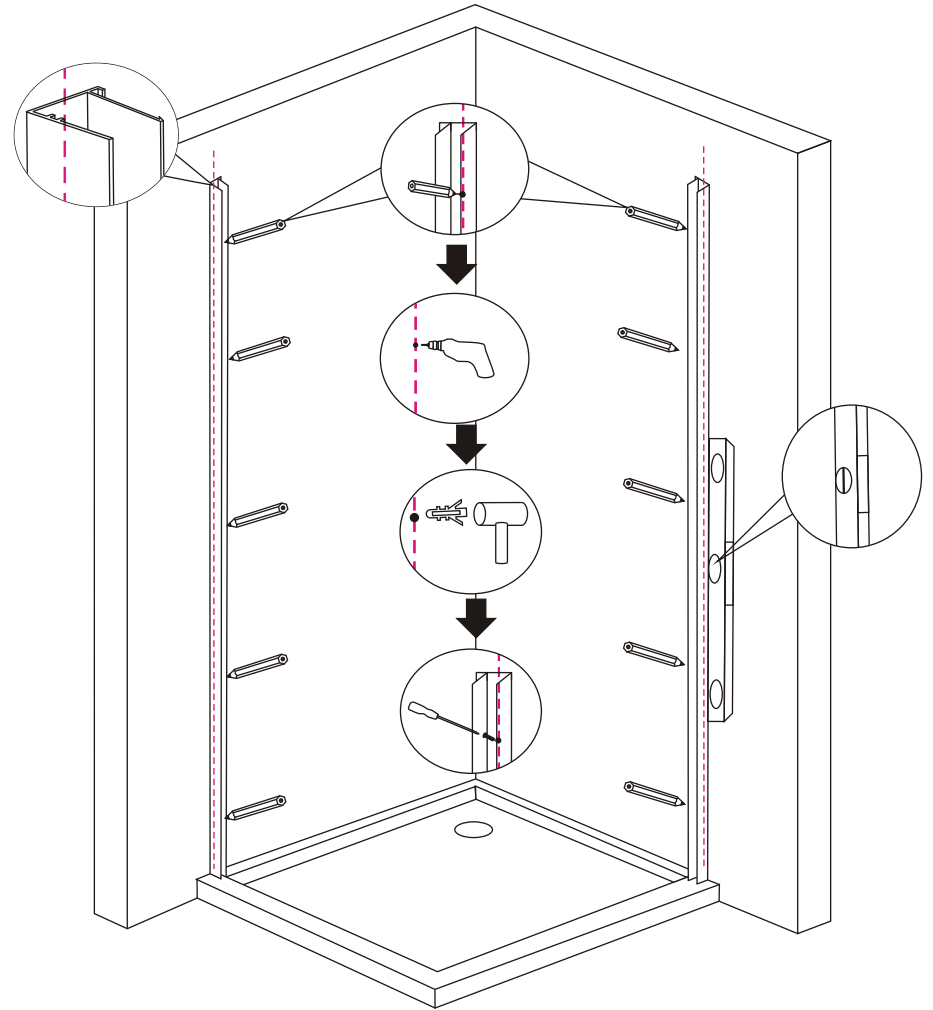
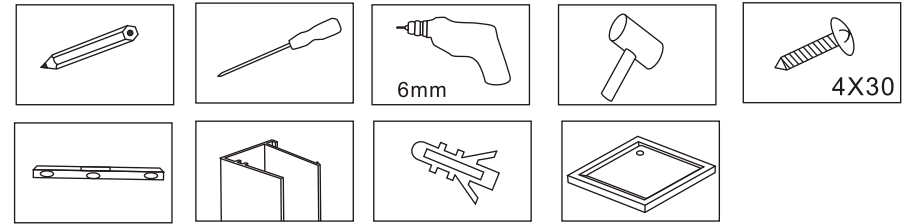

1.Insert the fixed door into wall aluminum profile.

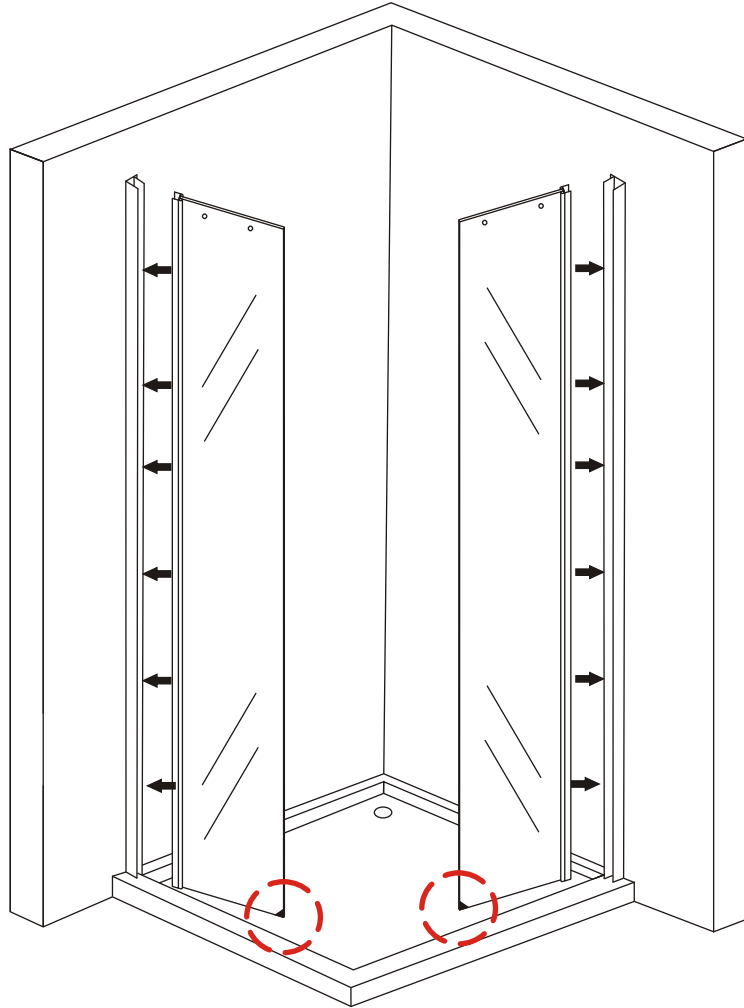
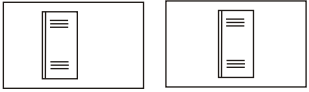

Attention: Do not remove the Black corner protector until insert well the glass into the wall profiles and fit well to prevent glass broken and splitted.



- 1.Insert the sliding door into the sliding rail.
- 2.Insert stright track in the track.
- 3.Use the Professional tools fixed the glass and the sliding track.
- 4.Connect the track.

